



# SOLAR MONTAJ SİSTEMLERİ

# SOLAR MOUNTING SYSTEM

[www.mastechmakina.com](http://www.mastechmakina.com)





**SÜRDÜRÜLEBİLİR BİR  
GELECEĞİ YENİLENEBİLİR  
ENERJİYLE BAŞLATMAK İÇİN  
MASTECH SOLAR ENERJİ**

**TO START A SUSTAINABLE FUTURE  
WITH RENEWABLE ENERGY**

**MASTECH SOLAR ENERGY**

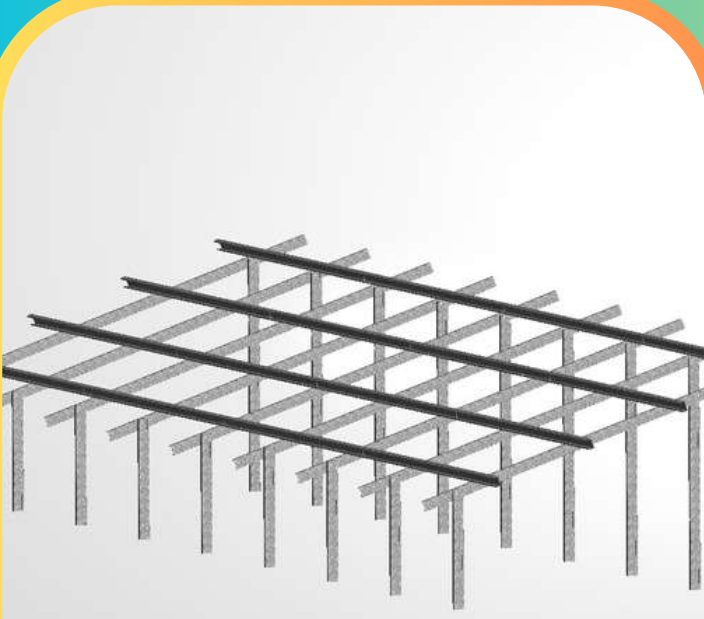

## ARAZİ MONTAJ SİSTEMLERİ

- Paslanmaz Çelik, Sıcak Daldırma Galvaniz, Pre-Galvaniz
- Projeye göre tasarım ve imalat
- Yatay & Dikey Tasarım



## LAND MOUNTING SYSTEM APPLICATION

- Stainless Steel, Hot Dip Galvanized, Pre-Galvanized
- Design and manufacturing according to the project
- Horizontal & Vertical Design

MSE-MCK550

1



+90 533 073 04 97 +90 533 073 04 98



www.mastechmakina.com



## DÜZ MEBRAN ÇÖZÜMLERİ

### FLAT MEMBRANE SOLUTION



## KİREMİT ÇATI MONTAJ ÇÖZÜMLERİ

### MOUNTING SOLUTION FOR TILE ROOF

MSE-MCK550

2



+90 533 073 04 97

+90 533 073 04 98



www.mastechmakina.com



## ORTA KLEMP

## MID CLAMP

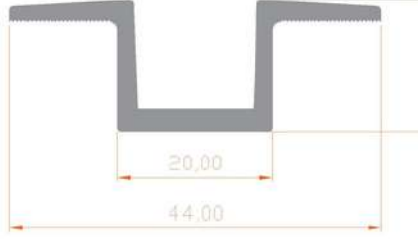

- Alüminyum 6063 T6
- istenilen boyda üretilebilir.
- Korozyona karşı dirençli
- H:30,35,40,42,45 mm panellere uyumlu
- Pimli model üretilebilir.

- Aluminum 6063 T6
- Produced in requested size.
- Corrosion resistant
- Suitable for H:30,35,40,42,45 mm panels
- Pin models can be produced.

MSE-MC01

## ORTA KLEMP

## MID CLAMP

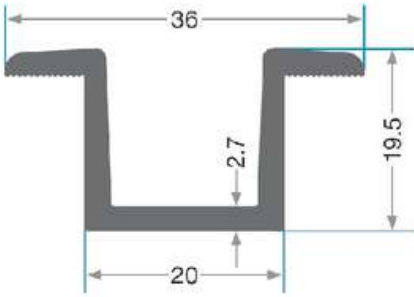

- Alüminyum 6063 T6
- istenilen boyda üretilebilir.
- Korozyona karşı dirençli
- H:30,35,40,42,45 mm panellere uyumlu

- Aluminum 6063 T6
- Produced in requested size.
- Corrosion resistant
- Suitable for H:30,35,40,42,45 mm panels

MSE-MCK797

## ORTA KLEMP

## MID CLAMP

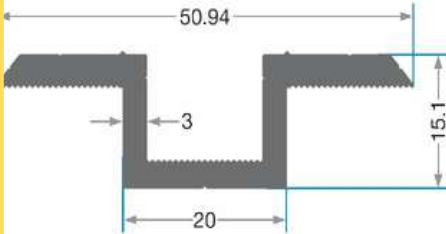

- Alüminyum 6063 T6
- istenilen boyda üretilebilir.
- Korozyona karşı dirençli
- H:30,35,40,42,45 mm panellere uyumlu

- Aluminum 6063 T6
- Produced in requested size.
- Corrosion resistant
- Suitable for H:30,35,40,42,45 mm panels

MSE-MCK550

3



+90 533 073 04 97

+90 533 073 04 98



www.mastechmakina.com

## ORTA KLEMP

## MID CLAMP

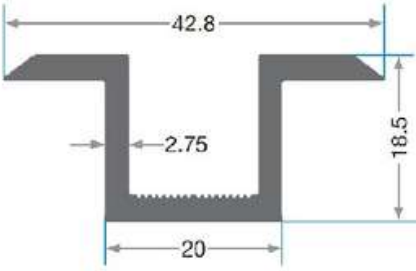

- Alüminyum 6063 T6
- istenilen boyda üretilebilir.
- Korozyona karşı dirençli
- H:30,35,40,42,45 mm panellere uyumlu

- Aluminum 6063 T6
- Produced in requested size.
- Corrosion resistant
- Suitable for H:30,35,40,42,45 mm panels

MSE-MCK787

## ORTA KLEMP

## MID CLAMP



- Alüminyum 6063 T6
- istenilen boyda üretilebilir.
- Korozyona karşı dirençli
- H:30,35,40,42,45 mm panellere uyumlu

- Aluminum 6063 T6
- Produced in requested size.
- Corrosion resistant
- Suitable for H:30,35,40,42,45 mm panels

MSE-MCO6717

## ORTA KLEMP

## MID CLAMP

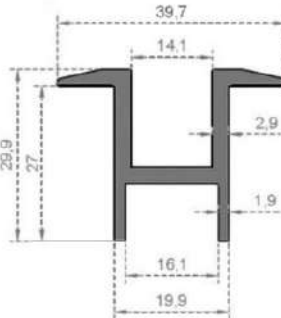

- Alüminyum 6063 T6
- istenilen boyda üretilebilir.
- Korozyona karşı dirençli
- H:30,35,40,42,45 mm panellere uyumlu

- Aluminum 6063 T6
- Produced in requested size.
- Corrosion resistant
- Suitable for H:30,35,40,42,45 mm panels

MSE-MCO6722

4



## SONLANDIRICI KLEMP END CLAMP

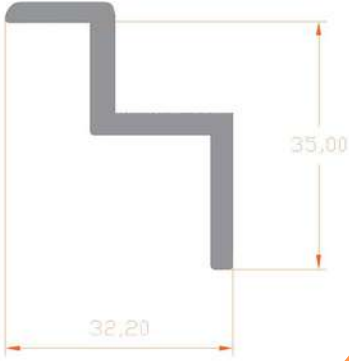

- Alüminyum 6063 T6
- istenilen boyda üretilebilir.
- Korozyona karşı dirençli
- H:35 mm panellere uyumlu
- Pimli model üretilebilir.
- Aluminum 6063 T6
- Produced in requested size.
- Corrosion resistant
- Suitable for H:35 mm panels
- Pin models can be produced.

MSE-EC01

## SONLANDIRICI KLEMP END CLAMP

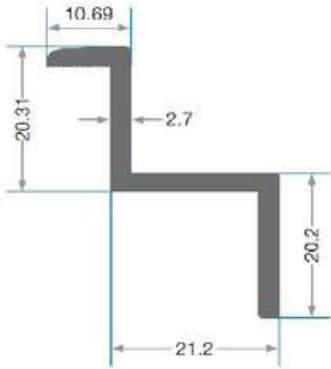

- Alüminyum 6063 T6
- istenilen boyda üretilebilir.
- Korozyona karşı dirençli
- H:35 mm panellere uyumlu
- Aluminum 6063 T6
- Produced in requested size.
- Corrosion resistant
- Suitable for H:35 mm panels

MSE-ECK798

## SONLANDIRICI KLEMP END CLAMP

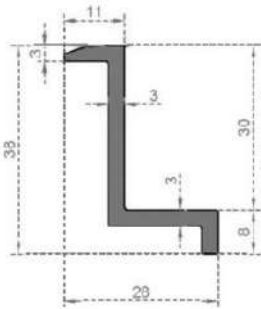

- Alüminyum 6063 T6
- istenilen boyda üretilebilir.
- Korozyona karşı dirençli
- H:35 mm panellere uyumlu
- Aluminum 6063 T6
- Produced in requested size.
- Corrosion resistant
- Suitable for H:35 mm panels.

MSE-ECO6711

5



## SONLANDIRICI KLEMP END CLAMP

- Alüminyum 6063 T6
- istenilen boyda üretilebilir.
- Korozyona karşı dirençli
- H:35 mm panellere uyumlu
- Aluminum 6063 T6
- Produced in requested size.
- Corrosion resistant
- Suitable for H:35 mm panels

MSE-ECK897

## SONLANDIRICI KLEMP END CLAMP

- Alüminyum 6063 T6
- istenilen boyda üretilebilir.
- Korozyona karşı dirençli
- H:35 mm panellere uyumlu
- Aluminum 6063 T6
- Produced in requested size.
- Corrosion resistant
- Suitable for H:35 mm panels

MSE-ECK785

## SONLANDIRICI KLEMP END CLAMP

- Alüminyum 6063 T6
- istenilen boyda üretilebilir.
- Korozyona karşı dirençli
- H:40 mm panellere uyumlu
- Aluminum 6063 T6
- Produced in requested size.
- Corrosion resistant
- Suitable for H:40 mm panels.

MSE-ECK22119

6





## SONLANDIRICI KLEMP END CLAMP

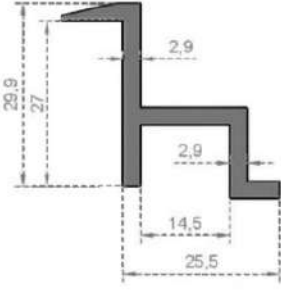

- Alüminyum 6063 T6
- istenilen boyda üretilebilir.
- Korozyona karşı dirençli
- H:30 mm panellere uyumlu
- Aluminum 6063 T6
- Produced in requested size.
- Corrosion resistant
- Suitable for H:30 mm panels

MSE-ECO6723

## SONLANDIRICI KLEMP END CLAMP

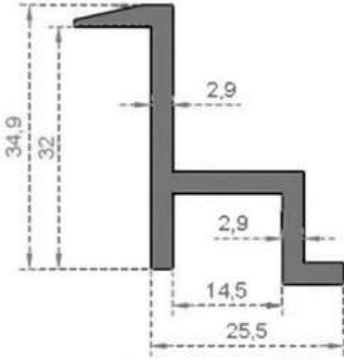

- Alüminyum 6063 T6
- istenilen boyda üretilebilir.
- Korozyona karşı dirençli
- H:35 mm panellere uyumlu
- Aluminum 6063 T6
- Produced in requested size.
- Corrosion resistant
- Suitable for H:35 mm panels

MSE-ECO6725

## SONLANDIRICI KLEMP END CLAMP

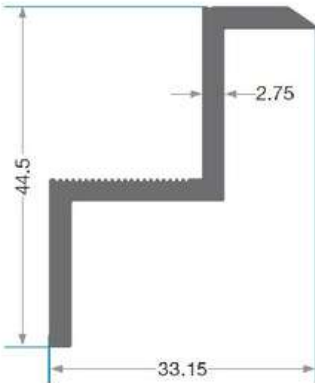

- Alüminyum 6063 T6
- istenilen boyda üretilebilir.
- Korozyona karşı dirençli
- H:35 mm panellere uyumlu
- Aluminum 6063 T6
- Produced in requested size.
- Corrosion resistant
- Suitable for H:35 mm panels.

MSE-ECK909

7



## SONLANDIRICI KLEMP END CLAMP

- Alüminyum 6063 T6
- istenilen boyda üretilebilir.
- Korozyona karşı dirençli
- H:40 mm panellere uyumlu
- Aluminum 6063 T6
- Produced in requested size.
- Corrosion resistant
- Suitable for H:40 mm panels

MSE-ECO6727

## SONLANDIRICI KLEMP END CLAMP

- Alüminyum 6063 T6
- istenilen boyda üretilebilir.
- Korozyona karşı dirençli
- H:40 mm panellere uyumlu
- Aluminum 6063 T6
- Produced in requested size.
- Corrosion resistant
- Suitable for H:40 mm panels

MSE-ECO6706

## RAY KLİPS

## RAIL CLIPS

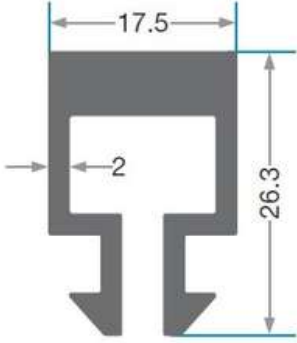

- Alüminyum 6063 T6
- istenilen boyda üretilebilir.
- Korozyona karşı dirençli

- Aluminum 6063 T6
- Produced in requested size.
- Corrosion resistant

MSE-RCK788

## KARE SOMUN

## SQUARE NUT

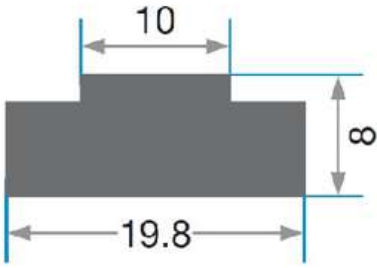

- Alüminyum 6063 T6
- istenilen boyda üretilebilir.
- Korozyona karşı dirençli

- Aluminum 6063 T6
- Produced in requested size.
- Corrosion resistant

MSE-SNK980

## KARE SOMUN

## SQUARE NUT

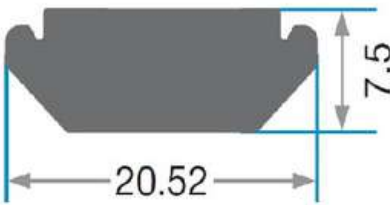

- Alüminyum 6063 T6
- istenilen boyda üretilebilir.
- Korozyona karşı dirençli

- Aluminum 6063 T6
- Produced in requested size.
- Corrosion resistant

MSE-SNK913

9





## ÇATI RAYI

## ROOF RAIL

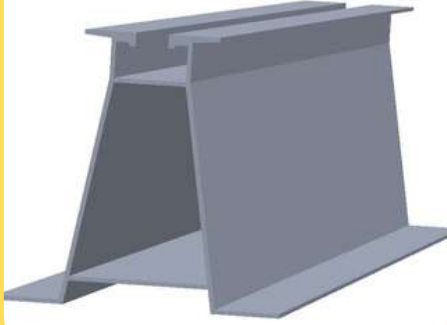

- Alüminyum 6063 T6
- istenilen boyda üretilebilir.
- Korozyona karşı dirençli
- H:80 mm

- Aluminum 6063 T6
- Produced in requested size.
- Corrosion resistant
- H:80 mm

MSE-RR01

## ÇATI RAYI

## ROOF RAIL

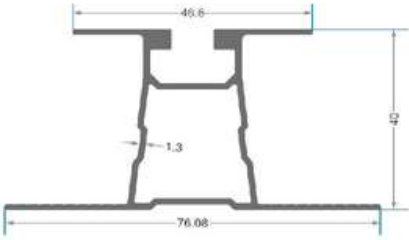

- Alüminyum 6063 T6
- istenilen boyda üretilebilir.
- Korozyona karşı dirençli
- H:40 mm

- Aluminum 6063 T6
- Produced in requested size.
- Corrosion resistant
- H:40 mm

MSE-RRK616

## ÇATI RAYI

## ROOF RAIL

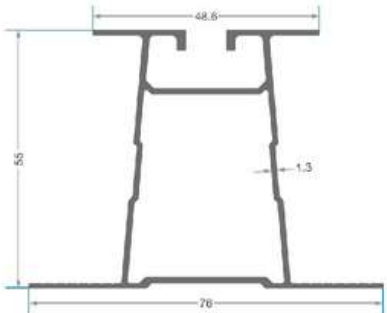

- Alüminyum 6063 T6
- istenilen boyda üretilebilir.
- Korozyona karşı dirençli
- H:55 mm

- Aluminum 6063 T6
- Produced in requested size.
- Corrosion resistant
- H:55 mm

MSE-RRK759

10



## ÇATI RAYI

## ROOF RAIL

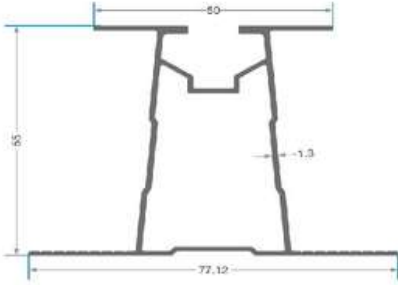

- Alüminyum 6063 T6
- istenilen boyda üretilebilir.
- Korozyona karşı dirençli
- H:55 mm

- Aluminum 6063 T6
- Produced in requested size.
- Corrosion resistant
- H:55 mm

MSE-RRK833

## ÇATI RAYI

## ROOF RAIL

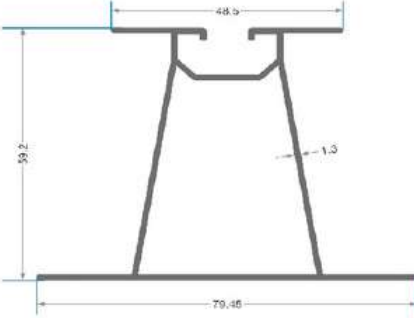

- Alüminyum 6063 T6
- istenilen boyda üretilebilir.
- Korozyona karşı dirençli
- H:59,2 mm

- Aluminum 6063 T6
- Produced in requested size.
- Corrosion resistant
- H:59,2 mm

MSE-RRK971

## ÇATI RAYI

## ROOF RAIL

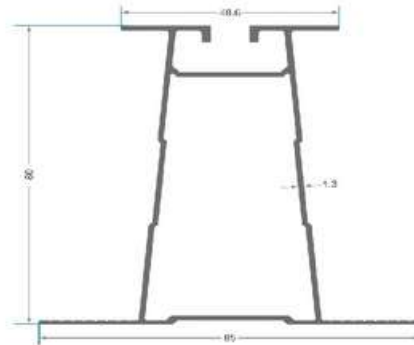

- Alüminyum 6063 T6
- istenilen boyda üretilebilir.
- Korozyona karşı dirençli
- H:80 mm

- Aluminum 6063 T6
- Produced in requested size.
- Corrosion resistant
- H:80 mm

MSE-RRK760

11



## ÇATI RAYI

## ROOF RAIL

- Alüminyum 6063 T6
- istenilen boyda üretilebilir.
- Korozyona karşı dirençli
- H:100 mm

- Aluminum 6063 T6
- Produced in requested size.
- Corrosion resistant
- H:100 mm

MSE-RRK829

## ÇATI RAYI

## ROOF RAIL

- Alüminyum 6063 T6
- istenilen boyda üretilebilir.
- Korozyona karşı dirençli
- H:100 mm

- Aluminum 6063 T6
- Produced in requested size.
- Corrosion resistant
- H:100mm

MSE-RRK972

## ÇATI RAYI

## ROOF RAIL

- Alüminyum 6063 T6
- istenilen boyda üretilebilir.
- Korozyona karşı dirençli
- H:100 mm

- Aluminum 6063 T6
- Produced in requested size.
- Corrosion resistant
- H:100mm



## SİGMA ÇATI RAYI SIGMA ROOF RAIL

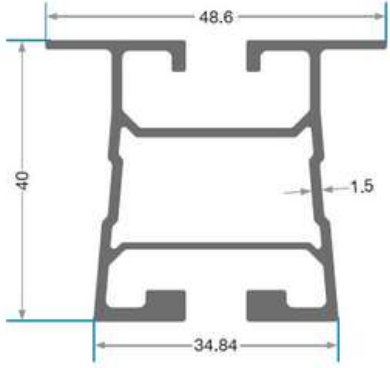

- Alüminyum 6063 T6
- istenilen boyda üretilebilir.
- Korozyona karşı dirençli
- H:40 mm
- Aluminum 6063 T6
- Produced in requested size.
- Corrosion resistant
- H:40 mm

**MSE-SRRK756**

## SİGMA ÇATI RAYI SIGMA ROOF RAIL

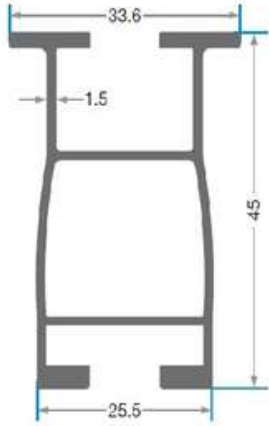

- Alüminyum 6063 T6
- istenilen boyda üretilebilir.
- Korozyona karşı dirençli
- H:45 mm
- Aluminum 6063 T6
- Produced in requested size.
- Corrosion resistant
- H:45 mm

**MSE-SRRK977**

## SİGMA ÇATI RAYI SIGMA ROOF RAIL

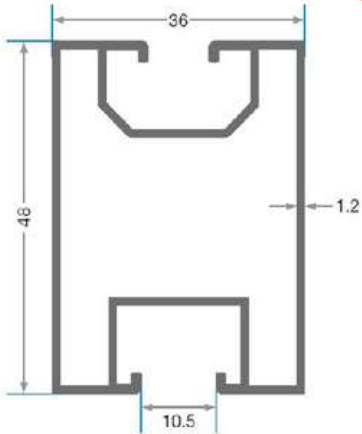

- Alüminyum 6063 T6
- istenilen boyda üretilebilir.
- Korozyona karşı dirençli
- H:48 mm
- Aluminum 6063 T6
- Produced in requested size.
- Corrosion resistant
- H:48 mm

**MSE-SRRK801**

13



## KENET ÇATI

## STANDING SEAM ROOF

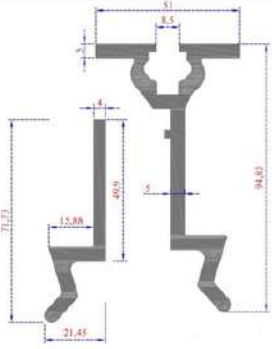

- Alüminyum 6063 T6
- istenilen boyda üretilebilir.
- Korozyona karşı dirençli
- Aluminum 6063 T6
- Produced in requested size.
- Corrosion resistant

MSE-SSR04

## KENET ÇATI

## STANDING SEAM ROOF



- Alüminyum 6063 T6
- istenilen boyda üretilebilir.
- Korozyona karşı dirençli
- Aluminum 6063 T6
- Produced in requested size.
- Corrosion resistant

MSE-SSR05

## KENET ÇATI

## STANDING SEAM ROOF



- Alüminyum 6063 T6
- istenilen boyda üretilebilir.
- Korozyona karşı dirençli
- Aluminum 6063 T6
- Produced in requested size.
- Corrosion resistant

MSE-SSR06

14



+90 533 073 04 97

+90 533 073 04 98



www.mastechmakina.com



**İMBUS CİVATA**

**HEXAGON SOCKET  
HEAD CAP SCREW**

**MSE-BSN01**



**ALÜMİNYUM KARE  
SOMUN**

**ALUMINUM  
SQAURE NUT**

**MSE-BSN02**



**FLANŞLI SOMUN**

**FLANGE NUT**

**MSE-BSN03**

**15**







**ALTIKÖŞE BAŞLI  
CİVATA**

**HEXAGON HEAD  
BOLT**

**MSE-BSN04**



**ALTIGEN SOMUN**

**HEXAGON NUT**

**MSE-BSN05**



**EJOT SİVRİ UÇLU  
ÇATI VİDASI**

**HEX HEAD SELF  
TAPPING SCREW**

**MSE-BSN06**

**16**





MEBRAN ÇATILAR  
İÇİN AYAK

SUPPORT FOR  
MEBRAN ROOFS

MSE-BSN07



EPDM BANT

EPDM BAND

MSE-BSN08



CONTALI PERÇİN

SELAED RİVET

MSE-BSN09

17





# MASTECH

SOLAR ENERJİ



## BİZİ TANIYIN

Mastech Makina, ülkemizin ve dünyanın geleceği olan güneş enerji sistemlerinde sektörün ihtiyaçlarına kalıcı çözüm üretmek amacıyla kurulmuştur. Bu amaç doğrultusunda teknik ekibi, yönetimi ve çalışanlarıyla birlikte sektörün önde gelen firmalarıyla çözüm ortaklığı içerisinde faaliyetine devam etmektedir.

## ABOUT US

Mastech Makina was established to produce permanent solutions for the needs of the sector in solar energy systems, which are the future of our country and the world. For this purpose, it continues its activities in solution partnership with the leading companies of the sector, together with its technical team, management and employees.

+90 533 073 04 97- 98

mastecmakina.com

satis@mastecmakina.com

Batıkent Mah. 8522. Cad. No:17/E  
Eyyübiye / ŞANLIURFA

